

## Zubehör

1 x Metallkappe

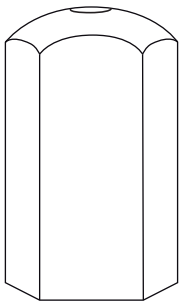

1 x Gewindeeinsatz

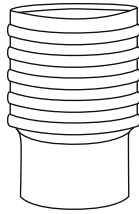

1 x Winkel

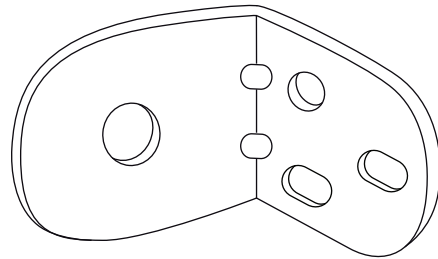

1 x Gummi



1 x Schraube kurz



4 x Dübel

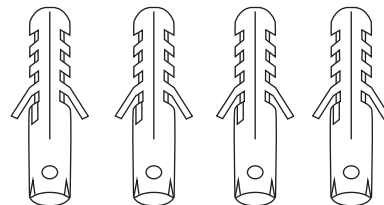

3 x Schrauben

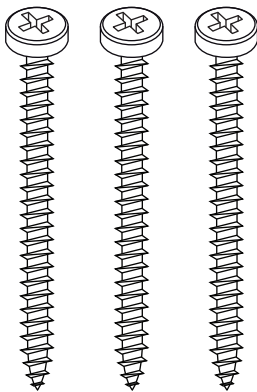

1 x Gewindestab



1 x Metalleinsatz mit  
2 x Feststellschrauben

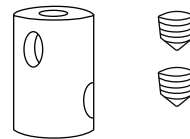

10m Edelstahlseil



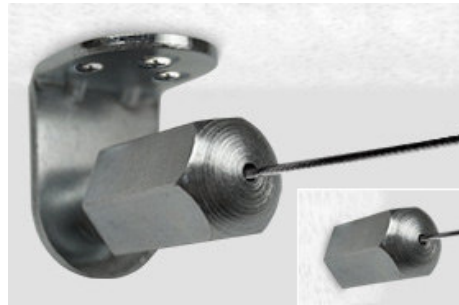

## Befestigung seitlich oben

Gewindeschraube und Gummi einsetzen

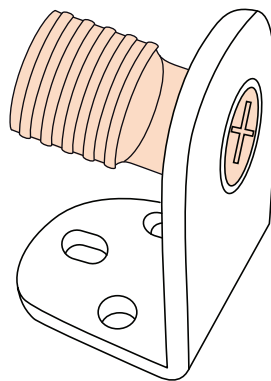
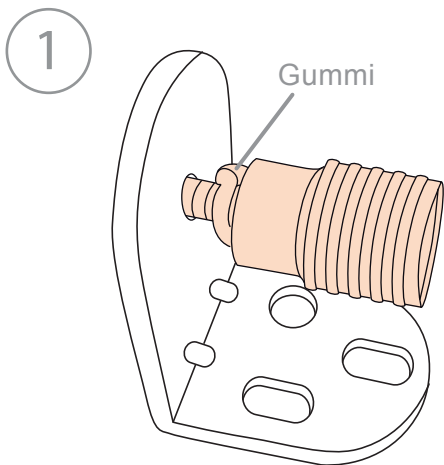

Schrauben fixieren

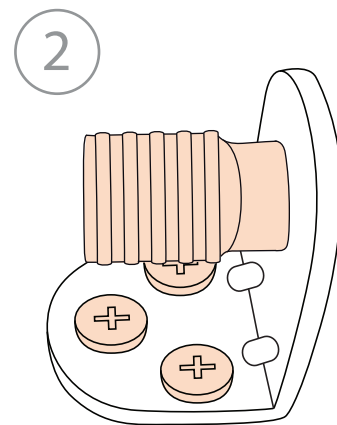

Fixieren des Drahtes mittels  
Inbusschlüssel

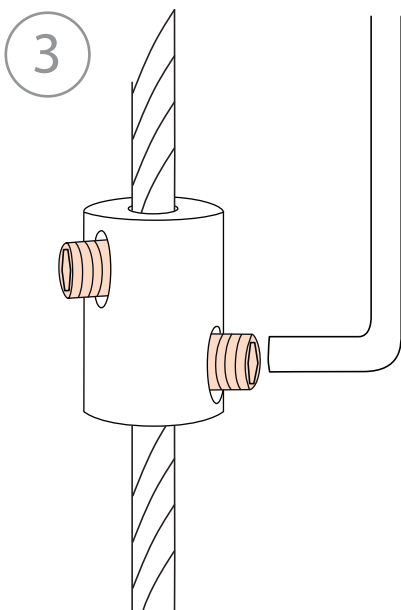

Fixieren des Drahtes

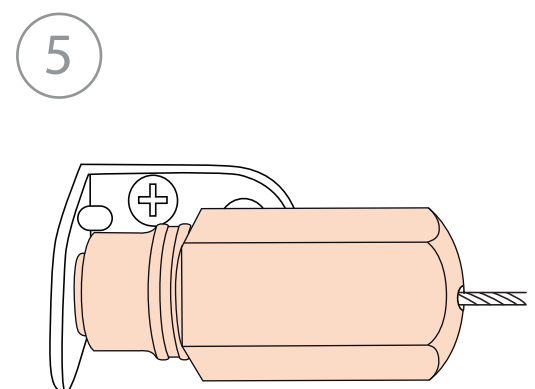
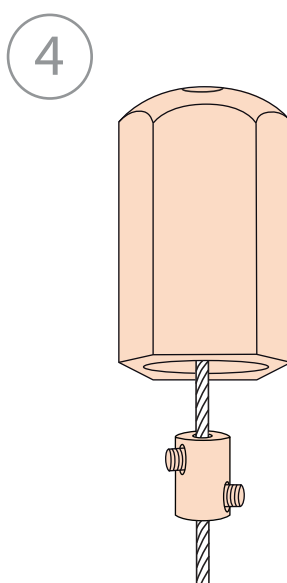

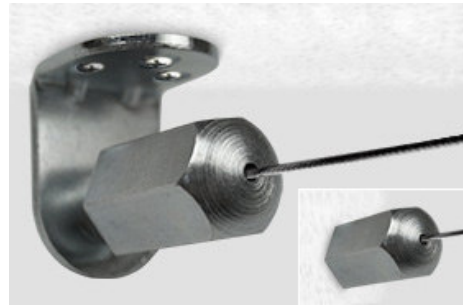

### Befestigung an der Stirnseite

Gewindeinsatz mittels Schraube befestigen

Metallzylinder anbringen

1 seitlich

frontal

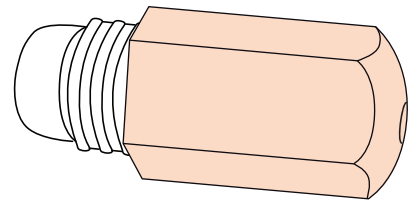
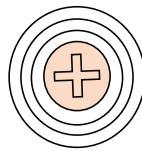
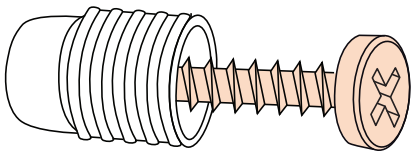

Fixieren des Drahtes mittels  
Inbusschlüssel

Fixieren des Drahtes

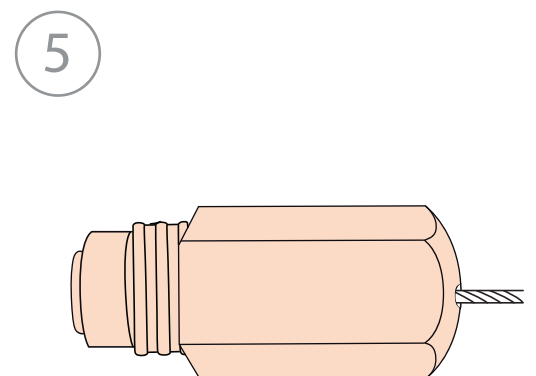
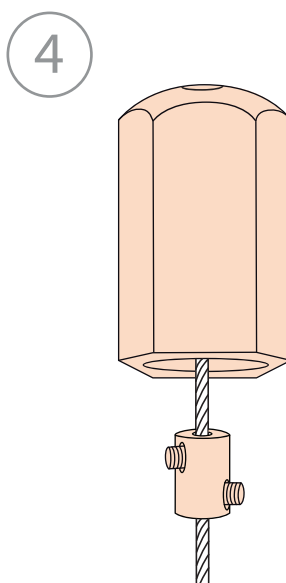
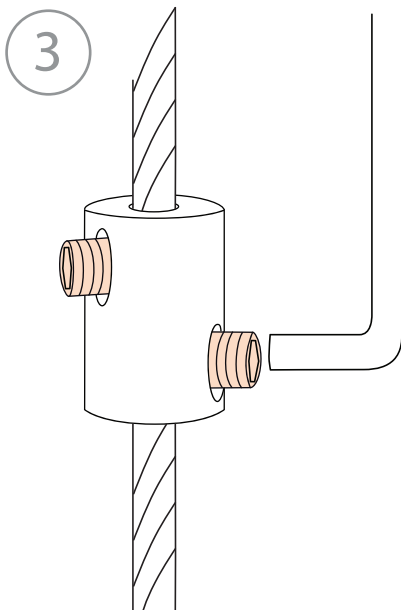

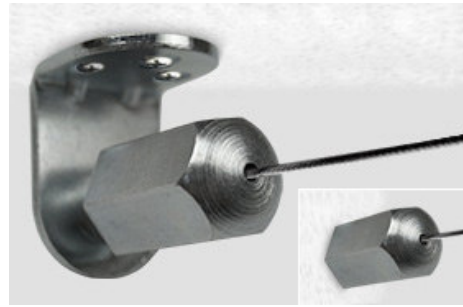

## Befestigung an der Stirnseite

optional  
Befestigung mittels Gewindestabes

1

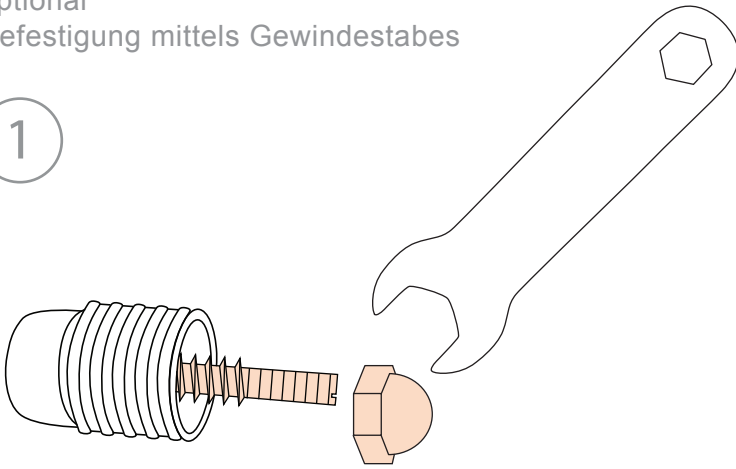

Metallzylinder anbringen

2

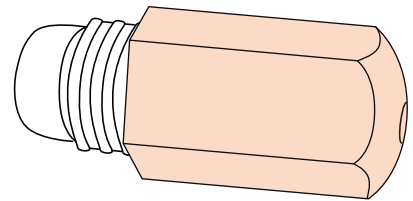

Fixieren des Drahtes mittels  
Inbusschlüssel

3

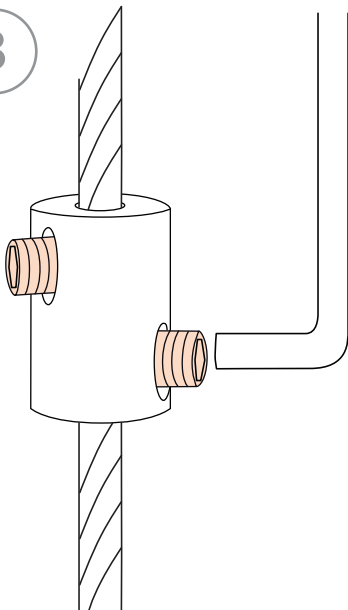

Fixieren des Drahtes

4

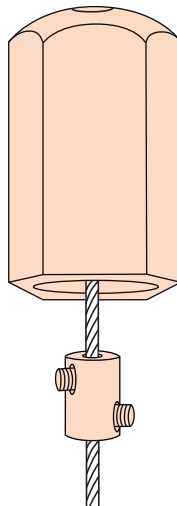

5

